



TX440 Advanced
TX600 Advanced
CEILING TRACK HOIST



**SPARE PARTS
MANUAL**

1. Contents

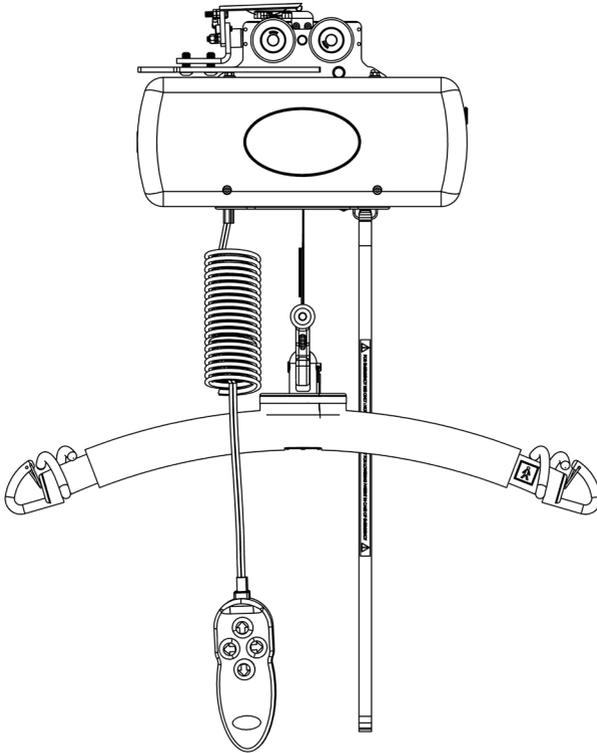

Description	Page(s)
Track Types	3
Spare Parts Summary	4-5
Part Code Detail	6-16
Notes	17-19
Contacts	20

2. Track Types

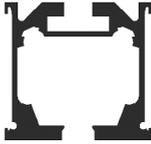
<p>Track Type 1</p> 	<p>Track Type 2</p> 
<p>Track Type 3</p> 	<p>Track Type 4</p> 
<p>Track Type 5</p> 	

3. Spare Parts Summary

Part Code	Description
122078-200	TX 2 Way PCB - 440 lb/200 kg SWL
122078-272	TX 2 Way PCB - 600 lb/272 kg SWL
122058-200	TX 4 Way PCB - 440 lb/200 kg SWL
122058-272	TX 4 Way PCB - 600 lb/272 kg SWL
122131-200	TX 6 Way PCB - 440 lb/200 kg SWL
122131-272	TX 6 Way PCB - 600 lb/272 kg SWL
122073	TX 2 Way Handset
122081	TX 4 Way Handset
122349	TX 4 Way Handset (Powered Aux)
122075	TX 6 Way Handset
122018	TX 2 Way Grommet & Air Tube Assembly
122019	TX 4 Way Grommet & Air Tube Assembly
122121	TX 4 Way Grommet/Tube (Powered Aux)
122082	TX 6 Way Grommet & Air Tube Assembly
122009	TX Lift Motor
101026	TX Drive Motor
122906	TX Traverse Gears Kit
122012	TX Hub Assembly
122003	TX Limit Switch Assembly
122801	TX Battery Set (Pair)
122050	TX Strap Pin
122020	TX Emergency Lower Switch Assembly
122011	TX Emergency Lower Cord
430061	TX QRS Hook Assembly
600075	TX QRT Trolley Set (Track Type 1)
810010	TX QRT Trolley Set (Track Type 5)
122907	TX QRT Locking Pin & Chain Assembly
300501	TX 440 lb/200 kg Carry Bar Assembly
300500	TX 600 lb/272 kg Carry Bar Assembly

Part Code	Description
440042	TX 440 lb/200 kg Lift Tape Assembly
440041	TX 600 lb/272 kg Lift Tape Assembly
122900	TX440 Advanced Cover Set (Driven)
122901	TX600 Advanced Cover Set (Driven)
122902	TX440 Advanced Cover Set (Powered "H")
122903	TX600 Advanced Cover Set (Powered "H")
122016	TX440 Advanced Cover Set (Manual)
122004	TX600 Advanced Cover Set (Manual)
122806	TX Wheel & Axle Kit (Track Type 1)
122810	TX Wheel & Axle Kit (Track Type 2)
122811	TX Wheel & Axle Kit (Track Type 3)
122812	TX Wheel & Axle Kit (Track Type 4)
122813	TX Wheel & Axle Kit (Track Type 5)
122100	TX Charger Assembly (Track Type 1)
122327	TX Charger Assembly (Track Type 2)
122326	TX Charger Assembly (Track Type 3/4/5)
600021	TX Charging Beak (Track Type 1)
122122	TX Charging Beak (Powered Turntable)
140016	TX Charging Beak (Track Type 2/3/4/5)
122342	TX Constant Charge Beak (Track Type 1)
122351	TX Constant Charge Beak (Track Type 2)
122371	TX Constant Charge Beak (Track Type 3)
940120	TX Constant Charge Beak (Track Type 4)
122376	TX Constant Charge Beak (Track Type 5)
122158	TX CC Charger Assembly (TT 1/5)
122159	TX CC Charger Assembly (Track Type 2)
122373	TX CC Charger Assembly (Track Type 3)
122377	TX CC Charger Assembly (Track Type 4)
200071	TX "H" System Curly Cable
999674	Mackworth TX Advanced User Manual

4. Part Code Detail

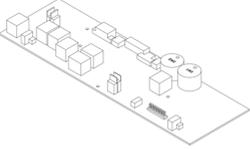
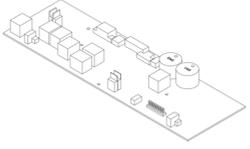
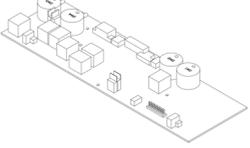
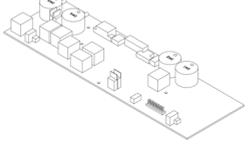
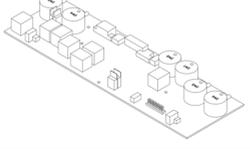
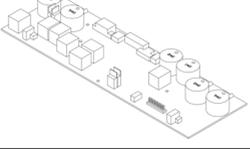
	<p>TX 2 Way PCB 440 lb/200 kg SWL 122078-200</p>
	<p>TX 2 Way PCB 600 lb/272 kg SWL 122078-272</p>
	<p>TX 4 Way PCB 440 lb/200 kg SWL 122058-200</p>
	<p>TX 4 Way PCB 440 lb/200 kg SWL 122058-272</p>
	<p>TX 6 Way PCB 440 lb/200 kg SWL 122131-200</p>
	<p>TX 6 Way PCB 440 lb/200 kg SWL 122131-272</p>

Part Code Detail

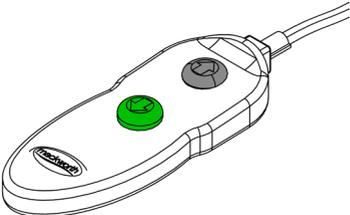
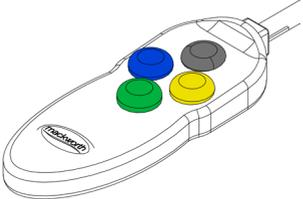
	<p>TX 2 Way Handset 122073</p>
	<p>TX 4 Way Handset 122081</p>
	<p>TX 4 Way Handset (Powered Aux) 122349</p>
	<p>TX 6 Way Handset 122075</p>

Part Code Detail

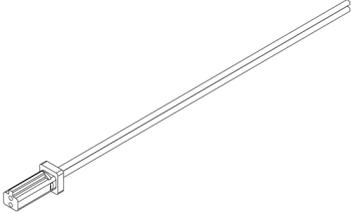
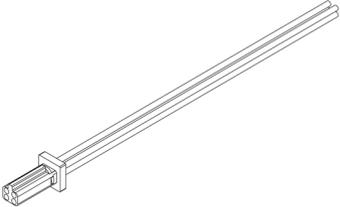
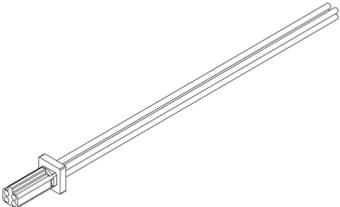
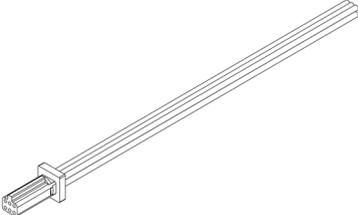
	<p>TX 2 Way Grommet & Air Tube Assembly 122018</p>
	<p>TX 4 Way Grommet & Air Tube Assembly 122019</p>
	<p>TX 4 Way Grommet & Air Tube Assembly (Powered Aux) 122121</p>
	<p>TX 6 Way Grommet & Air Tube Assembly 122082</p>

Part Code Detail

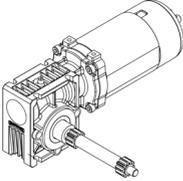
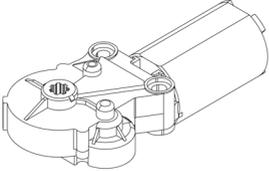
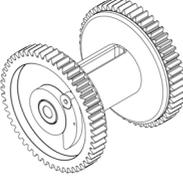
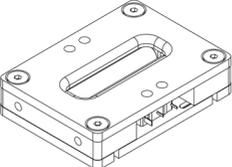
	<p>TX Lift Motor 122009</p>
	<p>TX Drive Motor 101026</p>
	<p>TX Traverse Gears Kit 122906</p>
	<p>TX Hub Assembly 122012</p>
	<p>TX Limit Switch Assembly 122003</p>

Part Code Detail

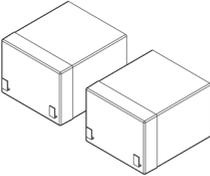
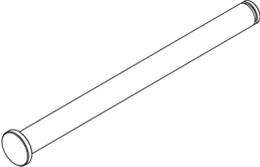
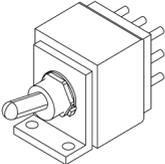
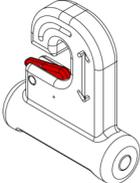
	<p>TX Battery Set (Pair) 122801</p>
	<p>TX Strap Pin 122050</p>
	<p>TX Emergency Lower Switch Assembly 122020</p>
	<p>TX Emergency Lower Cord 122011</p>
	<p>TX QRS Hook Assembly 433061</p>

Part Code Detail

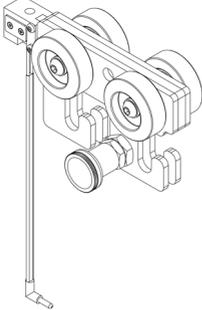
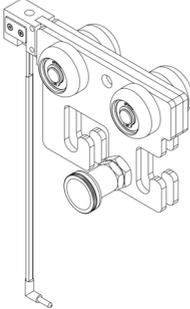
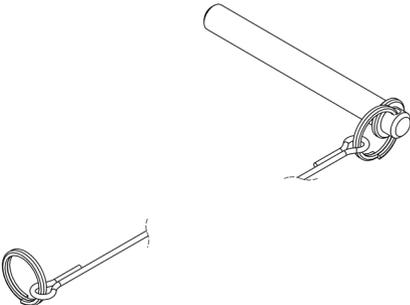
	<p>TX QRT Trolley Set (Track Type 1) 600075</p>
	<p>TX QRT Trolley Set (Track Type 5) 810010</p>
	<p>TX Locking Pin & Chain Assembly 122907</p>

Part Code Detail

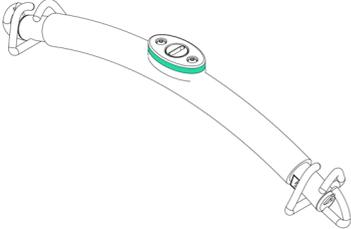
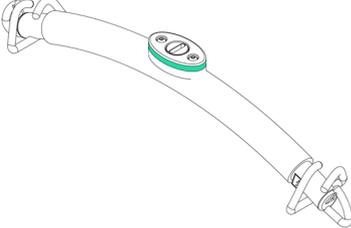
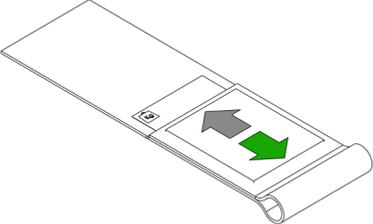
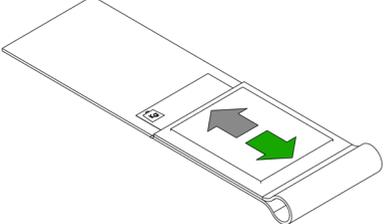
	<p>TX 440 lb/200 kg Carry Bar Assembly 300501</p>
	<p>TX 600 lb/272 kg Carry Bar Assembly 300500</p>
	<p>TX 440 lb/200 kg Lift Tape Assembly 440042</p>
	<p>TX 600 lb/272 kg Lift Tape Assembly 440041</p>

Part Code Detail

	<p>TX440 Advanced Cover Set (Driven) 122900</p>
	<p>TX600 Advanced Cover Set (Driven) 122901</p>
	<p>TX440 Advanced Cover Set (Powered "H") 122902</p>
	<p>TX600 Advanced Cover Set (Powered "H") 122903</p>
	<p>TX440 Advanced Cover Set (Manual) 122904</p>
	<p>TX600 Advanced Cover Set (Manual) 122905</p>

Part Code Detail

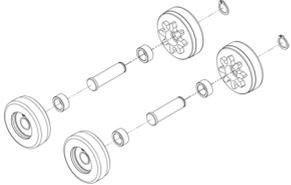
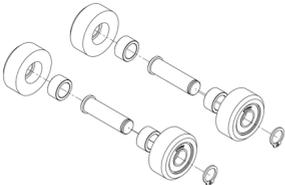
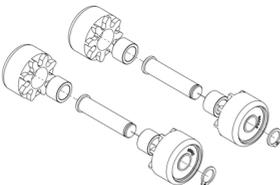
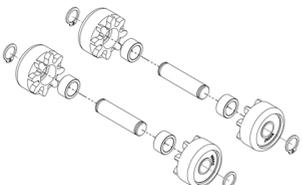
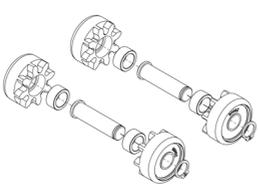
	<p>TX Wheel & Axle Kit (Track Type 1) 122806</p>
	<p>TX Wheel & Axle Kit (Track Type 2) 122810</p>
	<p>TX Wheel & Axle Kit (Track Type 3) 122811</p>
	<p>TX Wheel & Axle Kit (Track Type 4) 122812</p>
	<p>TX Wheel & Axle Kit (Track Type 5) 122813</p>

Part Code Detail

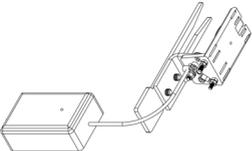
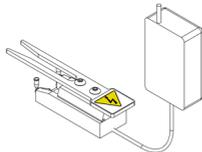
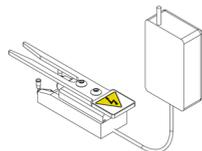
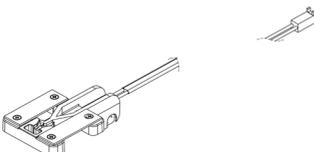
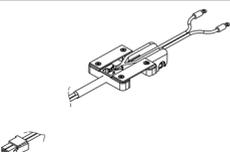
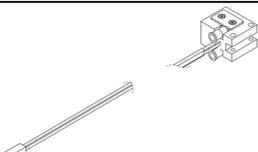
	<p>TX Charger Assembly (Track Type 1) 122100</p>
	<p>TX Charger Assembly (Track Type 2) 122327</p>
	<p>TX Charger Assembly (Track Type 3/4/5) 122326</p>
	<p>TX Charging Beak (Track Type 1) 600021</p>
	<p>TX Charging Beak (Powered Turntable) 122122</p>
	<p>TX Charging Beak (Track Type 2/3/4/5) 140016</p>

Part Code Detail

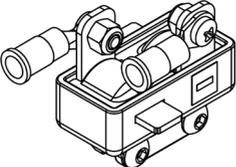
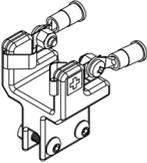
	<p>TX Constant Charge Beak (Track Type 1) 122342</p>
	<p>TX Constant Charge Beak (Track Type 2) 122351</p>
	<p>TX Constant Charge Beak (Track Type 3) 122371</p>
	<p>TX Constant Charge Beak (Track Type 4) 940120</p>
	<p>TX Constant Charge Beak (Track Type 5) 122376</p>

Part Code Detail

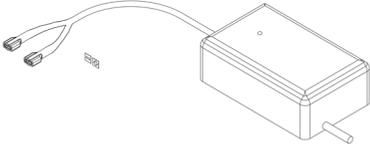
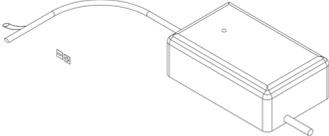
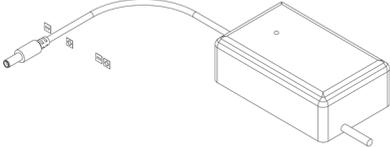
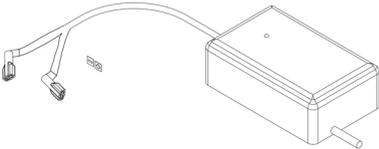
	<p>TX Constant Charge Charger Assembly (Track Type 1/5) 122158</p>
	<p>TX Constant Charge Charger Assembly (Track Type 2) 122159</p>
	<p>TX Constant Charge Charger Assembly (Track Type 3) 122373</p>
	<p>TX Constant Charge Charger Assembly (Track Type 4) 122377</p>
	<p>TX "H" System Curly Cable 200071</p>
	<p>Mackworth TX Advanced User Manual 999674</p>



5. Notes



Notes

6. Contacts

DEALER CONTACT DETAILS

MANUFACTURER CONTACT DETAILS

Unit 1, Tir Llwyd Industrial Estate, St Asaph Avenue, Kinmel Bay,
Conwy, United Kingdom, LL18 5JZ

Telephone: +44 (0)1924 840100

DISCLAIMER

While every effort has been made to ensure the accuracy of information contained in this manual, no liability can be accepted by Mackworth for any errors or omissions. Mackworth operates a policy of continuous improvement. Specifications and other data are subject to change without notice.

mackworthusa.com

